

Data sheet | Item number: 870-523/281-593

Component terminal block; double-deck; with suppressor diode; 24 VAC; for DIN-rail 35 x 15 and 35 x 7.5; 2.5 mm<sup>2</sup>; CAGE CLAMP®

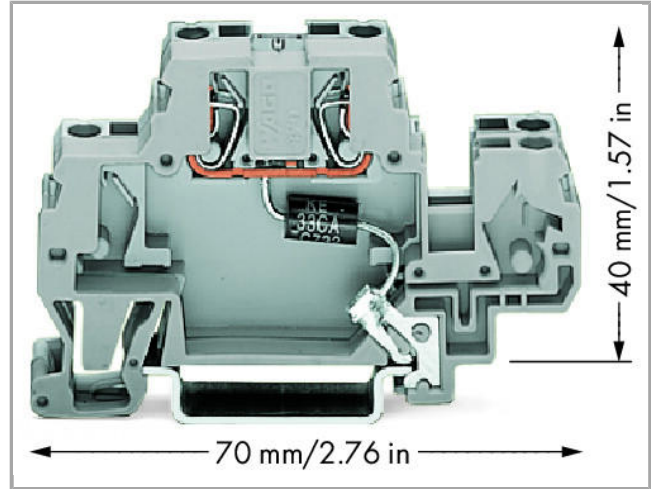

870-523/281-593



BOMcheck.net

Color: ■

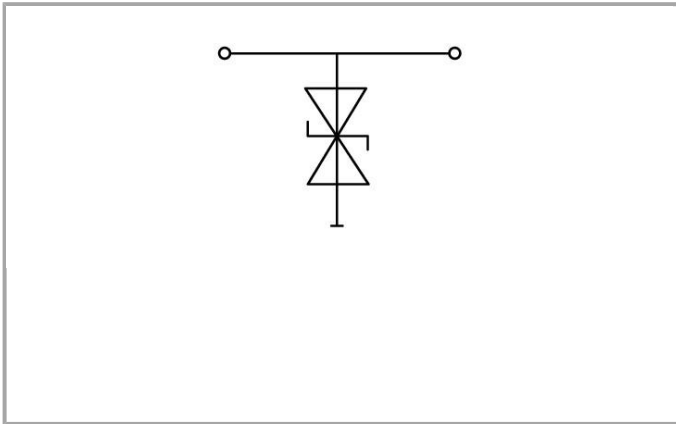

Data

Electrical data

Nominal operating voltage	AC 24 V
Maximum continuous operating voltage	AC 26 V
Rated continuous current	20 A
Nominal discharge current (8/20 $\mu$ s) per line	143 A
Voltage protection level (8/20 $\mu$ s)	$\leq$ AC 70 V
Response time line/line	$\leq$

Capacitance	≤ 2.4 nF
-------------	----------

### Connection data

Connections (number)	2
Connection technology	CAGE CLAMP®
Solid conductor	0.08 ... 2.5 mm <sup>2</sup> / 28 ... 14 AWG
Fine-stranded conductor	0.08 ... 4 mm <sup>2</sup> / 28 ... 12 AWG
Strip length	6 ... 7 mm / 0.24 ... 0.28 inch

### Geometrical Data

Width	10 mm / 0.394 inch
Height from upper-edge of DIN-35 rail	40 mm / 1.575 inch
Depth	70 mm / 2.756 inch

### Mechanical data

Type of mounting	DIN-35 rail
------------------	-------------

### Material Data

Color	gray
Fire load	0MJ
Weight	11.766 g

















### Commercial data













Product Group	16 (Rail Mounted Terminal Block with CCC)
Country of origin	DE
GTIN	4017332553773
Customs Tariff No.	85369010000

### Compatible products

#### Insulation stop

	<b>Item no.: 280-470</b> Insulation stop; 0.08 - 0.2 mm <sup>2</sup> "s" (0.14 mm <sup>2</sup> "f-st"); 5 pieces/strip	280-470
	<b>Item no.: 280-471</b> Insulation stop; 0.25 - 0.5 mm <sup>2</sup> ; 5 pieces/strip	280-471

	<b>Item no.: 280-472</b> Insulation stop; 0.75 - 1 mm <sup>2</sup> ; 5 pieces/strip	280-472
<b>Jumper</b>		
	<b>Item no.: 280-482</b> Comb-style jumper bar; insulated; 2-way; IN = IN terminal block	280-482
	<b>Item no.: 280-483</b> Comb-style jumper bar; insulated; 3-way; IN = IN terminal block	280-483
	<b>Item no.: 280-484</b> Comb-style jumper bar; insulated; 4-way; IN = IN terminal block	280-484
	<b>Item no.: 280-485</b> Comb-style jumper bar; insulated; 5-way; IN = IN terminal block	280-485
	<b>Item no.: 280-490</b> Comb-style jumper bar; insulated; 10-way; IN = IN terminal block	280-490
	<b>Item no.: 280-492</b> Alternate comb-style jumper bar; insulated; 2-way; IN = IN terminal block	280-492
<b>End plate</b>		
	<b>Item no.: 870-518</b> End and intermediate plate; 2 mm thick	870-518
	<b>Item no.: 870-519</b> End and intermediate plate; 2 mm thick	870-519
<b>Marking accessories</b>		
	<b>Item no.: 2009-145</b> Mini-WSB Inline; for Smart Printer; on reel; stretchable 5 - 5.2 mm; plain; snap-on type	2009-145
	<b>Item no.: 2009-145/000-002</b> Mini-WSB Inline; for Smart Printer; on reel; stretchable 5 - 5.2 mm; plain; snap-on type	2009-145 /000-002
	<b>Item no.: 2009-145/000-005</b> Mini-WSB Inline; for Smart Printer; on reel; stretchable 5 - 5.2 mm; plain; snap-on type	2009-145 /000-005
	<b>Item no.: 2009-145/000-006</b> Mini-WSB Inline; for Smart Printer; on reel; stretchable 5 - 5.2 mm; plain; snap-on type	2009-145 /000-006
	<b>Item no.: 2009-145/000-007</b> Mini-WSB Inline; for Smart Printer; on reel; stretchable 5 - 5.2 mm; plain; snap-on type	2009-145 /000-007
	<b>Item no.: 2009-145/000-012</b> Mini-WSB Inline; for Smart Printer; on reel; stretchable 5 - 5.2 mm; plain; snap-on type	2009-145 /000-012
	<b>Item no.: 2009-145/000-023</b> Mini-WSB Inline; for smartPRINTER; on reel; stretchable 5 - 5.2 mm; plain; snap-on type	2009-145 /000-023

	<b>Item no.: 2009-145/000-024</b> Mini-WSB Inline; for Smart Printer; on reel; stretchable 5 - 5.2 mm; plain; snap-on type	2009-145 /000-024
	<b>Item no.: 248-501</b> Miniature WSB Quick marking system; plain; Marker width 5 mm; 10 strips with 10 markers per card	248-501
	<b>Item no.: 248-501/000-002</b> Mini-WSB marking card; as card; not stretchable; plain; snap-on type	248-501 /000-002
	<b>Item no.: 248-501/000-005</b> Mini-WSB marking card; as card; not stretchable; plain; snap-on type	248-501 /000-005
	<b>Item no.: 248-501/000-006</b> Mini-WSB marking card; as card; not stretchable; plain; snap-on type	248-501 /000-006
	<b>Item no.: 248-501/000-007</b> Mini-WSB marking card; as card; not stretchable; plain; snap-on type	248-501 /000-007
	<b>Item no.: 248-501/000-012</b> Mini-WSB marking card; as card; not stretchable; plain; snap-on type	248-501 /000-012
	<b>Item no.: 248-501/000-017</b> Mini-WSB marking card; as card; not stretchable; plain; snap-on type	248-501 /000-017
	<b>Item no.: 248-501/000-023</b> Mini-WSB marking card; as card; not stretchable; plain; snap-on type	248-501 /000-023
	<b>Item no.: 248-501/000-024</b> Mini-WSB marking card; as card; not stretchable; plain; snap-on type	248-501 /000-024
	<b>Item no.: 709-198</b> Marking strips	709-198
<b>tools</b>		
	<b>Item no.: 210-720</b> Operating tool with partially insulated shaft; Type 2, blade (3.5 x 0.5) mm	210-720

**Downloads**

**Documentation**

**Additional Information**

Disposal; Electrical and electronic equipment, Packaging	V 1.0.0	pdf 265.8 kB	Download
--	---------	-----------------	----------



**CAD/CAE - Smart Data**

CAD data

3D Download 870-523/281-593

URL

Download

---

Subject to changes.

---